

References to Articles Descriptive of Railway Shops

- Armour Car Lines, Union Stock Yards. Car shops at Chicago, Ill. R. R. Gaz., Jan. 23, 1903. Ry. Age, Jan. 23, 1903.
- Armour Car Lines. Air Brake Testing Department of Car Repair Shops at Chicago. Ry. M. M., Dec., 1902.
- Atchison, Topeka & Santa Fe Railway. Locomotive Shops at Cleburne, Tex. Loc. Eng., April, 1900.
- Atchison, Topeka & Santa Fe Railway. Locomotive and Car Shops at Fort Madison, Iowa. R. R. Gaz., May 4, 1900.
- Atchison, Topeka & Santa Fe Railway. Locomotive and Car Shops at Topeka, Kan. Ry. M. M., serial, April to Oct., 1903. R. R. Gaz., Nov. 7, 1902. Ry. Age, July 2, 1907. Am. Eng., June, 1901; Sept., Oct., 1903. Eng. News, April 2, 1903.
- Atlantic Coast Line Railway. Locomotive Terminal at Waycross, Ga. Ry. M. M., April, 1906.
- Atlantic Coast Line Railway. Locomotive and Car Shops at Waycross, Ga. R. R. Gaz., June 9, 1905.
- Baltimore and Ohio Railroad. Locomotive Terminal at Holloway, O. Ry. M. M., June, 1903.
- Baltimore & Ohio Railroad. Locomotive Terminal at Keyser, W. Va. Ry. M. M., Nov., 1902.
- Baltimore & Ohio Railroad. Locomotive Terminals. Ry. Rev., Dec. 29, 1906.
- Buffalo, Rochester & Pittsburg Railroad. Locomotive Repair Shops at Dubois, Pa. Am. Eng., April, May, 1902. Ry. Rev., Feb. 14, 1903. Ry. Age, Feb. 13, 1903. Eng. Rec., Sept. 6, 1902. R. R. Gaz., Feb. 13, 1903.
- Canadian Pacific Railway. Locomotive and Car Shops at Angus, (Montreal) Can. Ry. M. M., April, May, August, 1905; Sept., Oct., Nov., 1906. Ry. Age, May 5, 1905; Oct. 17, 1902; Dec. 9, Dec. 16, 1904; Ry. Rev., Feb. 4, 1905. R. R. Gaz., Oct. 17, 1902. Am. Eng., Dec., 1904.
- Central Railroad of New Jersey. Locomotive and Car Shops at Elizabethport, N. J. R. R. Gaz., Dec. 27, 1901; Jan. 3, 1902. Ry. Age, Oct. 18, 1901. Am. Eng., Nov., 1901; Feb., 1902. Eng. Rec., Feb. 22, 1902; June 21, 1902.
- Chicago & Alton Railway. Locomotive and Car Shops at Bloomington, Ill. R. R. Gaz., June 27, 1902. Am. Eng., April, 1901.
- Chicago, Burlington & Quincy Railway (Hannibal and St. Joseph). Locomotive and Car Shops at Hannibal, Mo. Proceedings St. Louis Railway Club, May 16, 1902. R. R. Gaz., Oct. 5, 1900; Sept. 13, 1901. Ry. Age, Nov. 23, 1900; June 20, 1902.
- Chicago & Eastern Illinois Railway. Locomotive and Car Shops at Danville, Ill. Ry. M. M., June, Aug. 1904. Ry. Rev., Sept. 27, 1902; Aug. 22, 1903; July 9, 1904. Ry. Age, Nov. 20, 1903.
- Chicago Great Western Railway. Locomotive and Car Shops at Oelwein, Iowa. Ry. M. M., March, 1900. R. R. Gaz., June 21, 28, 1901. Ry. Rev., April 16, 1898; March 3, 10, 1900; June 25, 1904. Ry. Age, March 2, 1900.
- Chicago, Milwaukee & St. Paul Railway. Locomotive and Car Shops at Milwaukee, Wis. Ry. M. M., Feb., March, 1904. Am. Eng., Feb., 1899. R. R. Gaz., June 26, 1903. Ry. Age, Nov. 14, 1902. Eng. Rec., Nov. 14, 1903.
- Chicago & Northwestern Railway. Locomotive Terminal at Clinton, Iowa. Ry. M. M., Sept., 1900; March, 1901.
- Chicago & Northwestern Railway. Locomotive and Car Shops at Kinzie Street, Chicago, Ill. Ry. Age, May 30, 1902. Loc. Eng., Jan., 1902. Am. Eng., March, April, May, 1900. R. R. Gaz., Nov. 21, 1902.
- Chicago, Rock Island & Pacific Railway. Locomotive Shops at Silvis, Ill. Ry. M. M., Nov., Dec., 1904. Ry. Age, Aug. 21, 1903; Feb. 26, 1904; Aug. 19, 1905. Ry. Rev., Feb. 6, 1904. Eng. News, Feb. 11, 1904. R. R. Gaz., Feb. 5, 1904.
- Chicago, St. Paul, Minneapolis & Omaha Railway, St. Paul, Minn. Ry. Age, Aug. 22, 1902.
- Chicago, St. Paul, Minneapolis & Omaha Railway. Locomotive Shops at Sioux City, Iowa. R. R. Gaz., Sept. 11, 1903.
- Cleveland, Cincinnati, Chicago & St. Louis Railway. Locomotive and Car Shops at Beech Grove, (Indianapolis) Ind. Ry. Age, Aug. 3, 1906.
- Cincinnati, Hamilton & Dayton Railway. Locomotive and Car Shops at Ivorydale, O. Ry. Rev., Oct. 21, 1905; March 3, 1906. R. R. Gaz., Sept. 21, 1906. Eng. News, Oct. 11, 1906.
- Colorado & Southern Railway. Locomotive and Car Shops at Denver, Colo. R. R. Gaz., June 15, 1900. Am. Eng., Jan., 1901. Ry. Age, Nov. 14, 1900. Ry. Rev., Dec. 15, 1900.
- Delaware, Lackawanna & Western Railroad. Locomotive and Car Shops at Kingsland, N. J. Ry. M. M., April, 1906. Ry. Rev., June 9, 1906. Eng. Rec., Dec. 2, 1905. Ry. Age, Oct. 21, 1904.
- Delaware, Lackawanna & Western Railroad. Locomotive Shops at Scranton, Pa. Ry. Age, Oct. 28, 1904; April 12, 1907.
- Delaware, Lackawanna & Western Railroad. Car Shops at Scranton, Pa. Ry. M. M., Nov., 1906; Feb., March, 1907. R. R. Gaz., Jan. 9, 30, 1903. Ry. Rev., Jan. 17, Aug. 29, 1903. Ry. Age, Nov. 28, 1904.
- Delaware, Lackawanna & Western Railway. Locomotive Shops at East Buffalo, N. Y. Ry. Age, Dec. 30, 1904.
- Delaware & Hudson Railroad. Locomotive Terminal at Oneonta, N. Y. Ry. Eng., March, May, 1907.
- Denver & Rio Grande Railroad. Locomotive Terminals at Pueblo and Denver, Col. Ry. M. M., Dec., 1906; Jan., 1907. Ry. Eng., Dec., 1906; Jan., 1907.
- El Paso and Southwestern Railroad. Locomotive and Car Shops at El Paso, Tex. Ry. Eng., Feb., 1907. Ry. Rev., Dec. 29, 1906.
- Erie Railroad. Locomotive and Car Shops at Dunmore, Pa. Loc. Eng., Feb., 1902.
- Erie Railroad, Hornellsville, N. Y. Ry. Rev., Dec. 1, 1906. Am. Eng., Jan., 1907.
- Erie Railroad. Terminal Facilities. R. R. Gaz., June 15, 1906.
- Fort Worth & Denver City Railroad. Locomotive and Car Shops at Childress, Tex. R. R. Gaz., March 21, 1902.
- Grand Trunk Railway. Roundhouse at Mimico, Ont. Ry. Age, Sept., 22, 1905.
- Grand Trunk Railway. Locomotive Shops at Battle Creek, Mich. Ry. M. M., April, 1907. Ry. Age, March 8, 1907. Ry. Rev., March 9, 1907.
- Great Northern Railway. Locomotive Shops at Dale Street, St. Paul, Minn. R. R. Gaz., June 19, 1903. Am. Eng., June, 1903. Ry. Rev., June 20, 1903.
- Gulf & Ship Island Railroad. Locomotive and Car Shops at Gulfport, Miss. Ry. Rev., May 9, 1903.
- Hannibal & St. Joseph Railroad, Hannibal, Mo.. See Chicago, Burlington & Quincy.
- Illinois Central Railroad. Locomotive and Car Shops at Memphis, Tenn. R. R. Gaz., Oct. 17, 1902.
- Lake Shore & Michigan Southern Railway. Locomotive Terminal at Elkhart, Ind. Ry. M. M., Feb., March, 1905. Ry. Rev., April 1, Dec. 29, 1905. Am. Eng., Feb., March, 1905.
- Lake Shore & Michigan Southern Railway. Locomotive and Car Shops at Collinwood O. Ry. Age, April 11, 1902. Eng. News, Dec. 18, 1902. R. R. Gaz., Dec. 19, 1902. Am. Eng., serial, Oct. to Dec., 1902; Jan. to June, Sept. to Dec., 1903.
- Lehigh Valley Railroad. Locomotive and Car Shops at Sayre, Pa. Ry. Age, Sept. 30, 1904; Jan. 20, 1905; Dec. 22, 1905; May 29, June 19, 1903. Am. Eng., June, July, 1903. Eng. Rec., May 30, 1903. Eng. News, June 25, 1903; Jan. 26, 1905. R. R. Gaz., May 29, 1903; Jan. 27, 1905. Ry. Rev., April 28, 1900; June 20, 1903; Jan. 21, 1905.
- Louisville & Nashville Railroad. Locomotive and Car Shops at South Louisville, Ky. Ry. M. M., Nov., Dec., 1905; Jan., 1906. R. R. Gaz., June 9, 1905; March 9, 1906. Eng. News, Feb. 8, 1906. Ry. Rev., Oct. 7, Nov. 4, 1905.

- Mexican Central Railway. Locomotive and Car Shops at Aguas Calientes, Mex. R. R. Gaz., April 6, 1900; Aug. 5, 12, 19, 1904. Am. Eng., Dec., 1903; May, Sept., 1904. Ry. Age June 6, 1900; Aug. 12, 19, 1904.
- Michigan Central Railway. Locomotive Shops at Jackson, Mich. R. R. Gaz., April 23, 1897; Sept. 19, 1902. Ry. Age, June 20, 1902. Am. Eng., March, 1903.
- Minneapolis & St. Louis Railroad. Locomotive and Car Shops at Cedar Lake, Minneapolis, Minn. Ry. Age, June 6, 1902. Ry. Rev., June 21, 1902.
- Missouri, Kansas & Texas Railway. Gas Burning Heater with Fan System for Roundhouse at Parsons, Kans. Ry. M. M., Sept., 1906. Ry. Age, June 19, 1906.
- Missouri, Kansas & Texas Railway. Locomotive Shops at Parsons, Kans. Ry. Age, April 13, 1906.
- Missouri, Kansas & Texas Railway. Sedalia, Mo. Ry. Rev., Jan. 6, 1906.
- Missouri Pacific Railway. Locomotive and Car Shops at Sedalia, Mo. Ry. M. M., March, 1906. Ry. Rev., Jan. 6, 1906. R. R. Gaz., Sept. 9, Oct. 14, 1904. Ry. Age, Sept. 23, 1904.
- New York Central & Hudson River Railroad. Locomotive Shops at Depew N. Y. R. R. Gaz., Feb. 16, 1900. Eng. News, Dec. 21, 1893. Ry. Age, March 17, 1893. Loc. Eng., March, 1892. Ry. Rev., June 13, 1896; May 31, 1902.
- New York Central & Hudson River Railroad. Repair Shops for Steel Freight Car Trucks at East Buffalo, N. Y. Am. Eng., May, 1902.
- New York Central & Hudson River Railroad. Locomotive and Car Shops at Oak Grove, (Williamsport) Pa. Ry. M. M., June, 1902. Ry. Rev., May 31, 1902. R. R. Gaz., March 14, 1902.
- New York Central & Hudson River Railroad. Erecting Shop of the Locomotive and Car Shops at West Albany, N. Y. Ry. M. M., Nov., 1902.
- New York, New Haven & Hartford Railroad. Car Shops at Readville, Mass. Ry. M. M., April, 1904. Am. Eng., Feb., March, 1901. R. R. Gaz., Feb. 15, 1901. Ry. Age, July 26, 1901; March 28, 1902. Ry. Rev., June 18, 1904.
- New York, Ontario & Western Railway. Paint Shop Heating at Middletown, N. Y. Ry. M. M., June, 1907.
- New York, Ontario & Western Railway. Roundhouse at Middletown, N. Y. Ry. Age, June 30, 1905.
- Norfolk & Western Railway. Locomotive and Car Shops at Roanoke, Va. R. R. Gaz., June 20, 1902. Ry. Rev., July 12, 1902. Ry. Age, June 24, 1902.
- Northern Pacific Railway. Blacksmith Shop Ventilating System at Brainard, Minn. Ry. M. M., March, 1904.
- Oregon Short Line Railroad. Locomotive and Car Shops at Pocatello, Idaho. Ry. M. M., June, 1902. R. R. Gaz., June 27, 1902. Ry. Age, March 28, 1902. Ry. Rev., Feb. 7, 1903. Eng. News, Oct. 15, 1903.
- Pennsylvania Railroad. Locomotive Shops at Trenton, N. J. Ry. M. M., May, June, 1907. Ry. Age, Aug. 10, 1906; Sept. 9, 1904.
- Pennsylvania Railroad. Locomotive Terminal at East Altoona, Pa. Ry. Age, Jan. 19, 1906. R. R. Gaz., March 16, 1906. Am. Eng., Feb., March, 1906.
- Pennsylvania Railroad. Locomotive and Car Shops at Renova, Pa. Ry. Age, Aug. 14, 1903.
- Pennsylvania Lines, Northwest System. Locomotive Shops at Fort Wayne, Ind. R. R. Gaz., May 1, 1903.
- Pennsylvania Lines, Southwest System. (P., C., C. & St. L.) Locomotive and Car Shops at Columbus, O. Ry. Rev., Jan. 11, 1902. R. R. Gaz., April 17, 1903.
- Pennsylvania Railroad. Foundries at South Altoona, Pa. R. R. Gaz., March 17, 1905. Ry. Rev., June 10, 1905. Am. Eng., April, Sept., 1906.
- Pennsylvania Railroad. Locomotive Shops at Olean, N. Y. Ry. Age, Nov. 17, 1905.
- Pere Marquette Railroad. Locomotive Shops at Grand Rapids, Mich. Ry. M. M., Feb., 1905, March, 1905. Ry. Age, March 24, 1905. Ry. Rev., Oct. 29, Nov. 5, 1904.
- Philadelphia, Baltimore & Wilmington Railway. Locomotive and Car Shops at Wilmington, Del. R. R. Gaz., March 11, 1904. Ry. Age, April 8, 1904. Ry. Rev., June 16, 1906.
- Philadelphia & Reading Railroad. Locomotive Shops at Reading, Pa. R. R. Gaz., Dec. 12, 1902. Eng. News, May 24, 1900. Ry. Age, Nov. 10, 1899; May 23, 1902; March 6, 1903. Ry. Rev., May 19, 1900. Am. Eng., serial, Jan. to June, Oct., Nov., 1903.
- Pittsburg & Lake Erie Railroad. Locomotive and Car Shops at McKees Rocks, Pittsburg, Pa. R. R. Gaz., June 27, 1902. Eng. News, Aug. 14, 1902. Ry. Age, Feb. 28, April 18, 1902; Dec. 18, 1903. Ry. Rev., Dec. 5, 12, 26, 1903. Am. Eng., serial, Nov., 1903, to Feb., 1904, and Aug. to Oct., 1904.
- St. Louis, Iron Mountain & Southern Railway. Locomotive and Car Shops at Baring Cross, Ark. Ry. Age, March 2, 1900; June 13, 1902. Ry. Rev., June 14, 21, 1902.
- Seaboard Air Line Railway. Locomotive and Car Shops at Portsmouth. Ry. M. M., March, 1904. Ry. Age, Jan. 15, 1904.
- Southern Railway. Locomotive Shop at Spencer, N. C. R. R. Gaz., Nov. 25, 1904.
- Southern Railway. Locomotive and Car Shops at Sheffield, Ala. Ry. Age, May 16, 1902.
- Southern Railway. Locomotive Terminal. Ry. Rev., May 18, 1907.
- Southern California Railroad (A., T. & S. F.). Locomotive and Car Shops at San Bernardino, Cal. Ry. Age, Sept. 26, 1902. R. R. Gaz., Aug. 29, 1902.
- Southern Pacific Railway. Locomotive and Car Shops at East Los Angeles, Cal. R. R. Gaz., Aug. 14, 1903.
- Terminal Railroad Association of St. Louis. Locomotive Terminal at St. Louis, Mo. Ry. M. M., Oct., 1904. Ry. Age, July 29, 1904. Ry. Rev., Oct. 15, 1904.
- Terminal Railroad Association of St. Louis. Locomotive and Car Shops at East St. Louis, Ill. Ry. M. M., April, May, 1904. Ry. Rev., Feb. 20, 1904, April 16, 1904.
- Union Pacific Railway. Locomotive and Car Shops at Omaha, Neb. Ry. Age, Dec. 12, 1902.
- Wabash Railroad. Car Shops at East Decatur, Ill. Ry. Age, Jan. 4, 1907.
- Wabash Railroad. Locomotive Terminal at Landers, Ill. Ry. M. M., May, 1906.
- Wisconsin Central Railway. Locomotive and Car Shops at Fond du Lac, Wis. Ry. M. M., April, 1901. Ry. Rev., Jan. 19, 1901. Ry. Age, June 21, 28, 1901. Am. Eng., May, 1901.

REFERENCES TO GENERAL ARTICLES CONCERNING RAILWAY SHOPS.

- Railway Shops, by R. H. Soule. Serial, Am. Eng., 1903-1904. Introductory, Feb., 1903. General Considerations, March, 1903. The erecting shop, April, 1903. The machine shop, May, 1903. The boiler shop and the smith shop, June, 1903. The passenger car repair shop, Oct., 1903. The freight car repair shop and yard, Nov., 1903. The planing mill, Dec., 1903. The power plant, Jan., 1904. The storehouse, Feb., 1904. The foundry, March, 1904. The roundhouse, April, 1904. The layout, May, 1904. Conclusions, June, 1904.
- Railroad shops, by Walter G. Berg. Serial, R. R. Gaz., March 13-20, April 3-10, 1903.
- A Typical Shop to Serve a Road or Division Equipped with 300 Locomotives, by L. R. Pomeroy. Proceedings, American Railway Master Mechanics' Association, 1902. Eng. News, July 3, 1902. Ry. Rev., July 12, 1902. R. R. Gaz., Oct. 24, 1902. Am. Eng., Aug., 1902.
- Railroad Repair Shop Design and Equipment, by George A. Damon. Proceedings, Western Railway Club, April, 1903. Eng. News, May 14, 1903. Ry. Age, April 24, 1903.
- Ideal Blacksmith Shop and Equipment for General Railroad Work. Proceedings, International Railroad Master Blacksmiths' Association, 1904.

- Location of Tanks in Oil Houses. By L. T. Johnson. Central Railway Club, March, 1904.
- Compressed Air Pneumatic Tools in Railroad Service. By Thos. Aldcorn. Central Railway Club, May, 1904.
- Economic Management of Railroad Car Shops. Pacific Coast Railway Club, February, 1904.
- Modern Roundhouse Construction. By M. E. Merrill. New England Railroad Club, November, 1904.
- Repairs to Steel Freight Cars. By C. A. Seley (plan for proposed shop). *Am. Eng.*, June, 1900.
- Some Notes on Steel Car Repairing, (describing several railroad shops for repairing steel cars). *R. R. Gaz.*, June 5, 1903.
- Shop Practice and Maintenance of All Steel Cars. Central Railway Club, January, 1902.
- Motor Driven Machinery. By O. H. Bigelow. New England Railroad Club, December, 1902.
- Electrically Driven Shop. By R. L. Warner. New England Railroad Club, December, 1902.
- Best Shop Practice and Shop Changes for Repairing Steel Cars, Committee Report. Proceedings, Central Railway Club, Jan., 1902. *R. R. Gaz.*, Jan. 24, 1902.
- Machine Rating. By J. F. DeVoy. Western Railway Club, December, 1903.
- Machine Tools and High Speed Steel. By J. A. Carney. Western Railway Club, December, 1903.
- The Railroad Paint Shop. By W. O. Quest, Proceedings, Railway Club of Pittsburg, Nov., 1903. *R. R. Gaz.*, Dec. 11, 1903.
- The Arrangement of Boiler Shops. By F. M. Whyte. *Am. Eng.*, June, 1900.
- Power Transmission by Shafting vs. Electricity, committee report. Proceedings, American Railway Master Mechanics' Association, 1900.
- The Advantages of Electrically Driven Railroad Shops. By L. R. Pomeroy. Proceedings, Central Railway Club, Nov., 1902. and January, 1903. *Ry. Rev.*, Nov. 22, Dec. 27, 1902. *Ry. Age*, Nov. 21, 1902. *Am. Eng.*, Feb. 1903. *R. R. Gaz.*, Dec. 19, 1902.
- Modern Tendencies in the Development and Transmission of Power. By John J. Flather. Proceedings, American Association Advancement of Science, Dec., 1902. *Eng. News*, Jan. 1, 1903.
- Electric Driving for Shops. By C. A. Seley. Proceedings, American Railway Master Mechanics' Association, 1902. *Ry. M. M.*, July, 1902. *Ry. Rev.*, July 12, 1902. *R. R. Gaz.*, June 27, July 4, 1902. *Ry. Age*, Feb. 27, 1903. (Discussion, New York Railroad Club). *Eng. News*, July 3, 1902. *Am. Eng.*, July, 1902. *R. R. Gaz.*, May 12, 1905.
- Electrically Driven Shops, committee report. Proceedings, American Railway Master Mechanics' Association, 1903. *Ry. M. M.*, July, 1903. *R. R. Gaz.*, June 26, 1903. *Ry. Rev.*, Dec. 19, 1903. *Eng. News*, July 2, 1903. *Am. Eng.*, July, 1903. *Ry. Age*, June 26, 1903.
- Electricity in Railroad Shops. *R. R. Gaz.*, May 29, 1903.
- Machine Tools. By James K. Cullen. Proceedings, Western Railway Club, Nov., 1902. *Ry. Age*, Nov. 21, 1902.
- The Power Question in Locomotive Repair Shops. By R. W. Stovel. Proceedings, Railway Club of Pittsburg. *Ry. Age*, April 4, 1902. *Ry. Rev.*, June 14, 1902.
- The Value of Up to Date Tools in Railroad Shops. By M. K. Barnum. Proceedings, Western Railway Club, March, 1902. *Ry. M. M.*, April, 1902. *R. R. Gaz.*, March 21, 1902.
- Electric Equipment in Modern Machine Shop Practice. By F. B. Duncan. Proceedings, Engineers Society of Western Pennsylvania, May, 1902.
- Heating and Ventilating of Railroad Shops. By J. I. Lyle. Proceedings, New York Railroad Club, March, 1903. *Ry. Age*, April 3, 1903. *R. R. Gaz.*, March 27, 1903.
- Heating and Ventilating Car and Locomotive Paint Shops. By W. H. Dutton. Proceedings, Master Car and Locomotive Painters' Association, Sept., 1903. *Ry. Age*, Sept. 11, 1903.
- The Economical Heating of Railway Repair Shops. By W. H. Carrier. *Ry. Age*, June 30, 1903.
- Lengthening Roundhouse Stalls. *Ry. M. M.*, May, 1901.
- Up to Date Roundhouses. Proceedings, American Railway Railway Master Mechanics' Association, 1901. *Ry. M. M.*, July, 1901.
- Cranes for Railway Shops. By G. R. Brandon. *Ry. M. M.*, March, 1903.
- Electric Wiring of Machine Tools. *Ry. M. M.*, April, 1904.
- Variable Speed Motors. By C. A. Seley. Proceedings, American Railway Master Mechanics' Association, 1904. *Ry. M. M.*, July, 1904. *Am. Eng.*, Aug., 1904. *R. R. Gaz.*, July 1, 1904.
- Terminals for Locomotives. Proceedings, American Railway Master Mechanics' Association, 1904. *Ry. M. M.*, July, 1904.
- A Marked Advance in Locomotive Boiler Maintenance. By A. R. Raymer. Proceedings, Western Railway Club, Oct., 1904. *Ry. M. M.*, Nov., 1904. *Ry. Age*, Oct. 21, 1904. *R. R. Gaz.*, Oct. 21, 1904. *Am. Eng.*, Nov., 1904.
- Equipment for a Modern Blacksmith Shop for Railway Work. By A. W. McCaslin. Proceedings, National Railroad Master Blacksmiths' Association, 1904. *Ry. M. M.*, Nov., 1904.
- Systems of Electrical Distribution in Railway Shops. By J. Henry Klinck. *Ry. M. M.*, April, 1905.
- The Organization of Railway Shop Forces. By H. T. Bentley. Western Railway Club, September, 1905.
- Ideal Blacksmith Shop. Proceedings, International Railroad Master Blacksmiths' Association, 1905.
- Saw Tooth Skylights in Factory Roof Construction. By F. S. Hynes. Proceedings, American Society of Mechanical Engineers, 1906.
- Saw Tooth Roofs for Factories. By K. C. Richmond. Proceedings, American Society of Mechanical Engineers, 1906.
- The Art of Cutting Metals. By Fred W. Taylor. Proceedings, American Society of Mechanical Engineers, 1906.
- Electric Light Wiring for Roundhouses. *Ry. M. M.*, Aug., 1906.
- Railroad Repair Shops. By G. R. Henderson. New England Railroad Club, April, 1907.
- Transfer Tables for Locomotive Shops. *Ry. M. M.*, Jan., Feb., 1907.
- Freight Car Repair Facilities. *Ry. M. M.*, Dec., 1906; Jan., Feb., 1907.
- Reinforced Concrete Roundhouses. *Ry. Rev.*, March 17, 1906.
- American Roundhouses and Their Operations. By W. E. Dunham. *R. R. Gaz.*, May 19, 1905.
- Recommendations Relative to the Requirements of a Modern Roundhouse. Proceedings, American Railway Engineering and Maintenance of Way Association, 1905. *Ry. Age*, March 24, 1905.
- Locomotive Terminal Facilities. Proceedings, American Railway Master Mechanics' Association, 1905. *Ry. M. M.*, July, 1905. *Ry. Age*, June 16, 1905. *Am. Eng.*, Aug., 1905. *R. R. Gaz.*, June 16, 1905.
- Shop Layouts. Proceedings, American Railway Master Mechanics' Association, 1905. *Ry. M. M.*, July, 1905. *Ry. Age*, June 17, 1905. *Ry. Rev.*, June 17, 1905.
- Buildings. Proceedings, American Railway Engineering and Maintenance of Way Association, 1906. *Ry. Age*, March 23, 1906.
- Organization and Economy in the Railway Machine Shop. By H. W. Jacobs. *Eng. Mag.*, serial beginning Sept., 1906.
- Some Small Successful Shop Savings. By C. J. Crowley. Proceedings, Western Railway Club, Feb., 1906.
- The Development of Railroad Shop Practice in the United States. By M. K. Barnum. *R. R. Gaz.*, May 5, 1905.
- Roundhouse Framing. By R. D. Coombs. Proceedings, American Society of Civil Engineers. *R. R. Gaz.*, June 9, 1905.

Improved Roundhouse Facilities. By J. C. Stuart. *R. R. Gaz.*, June 15, 1906.

Square Roundhouse. By G. P. Nichols. *Proceedings, Western Railway Club*, Feb., 1904. *Ry. Age*, Feb. 19, 1904.

Shop Management, Organization and Methods. By H. A. Lyddon. *Proceedings, North West Railway Club*, March, 1904. *Ry. Rev.*, May 14, 1904.

Shop Management. By F. A. Parkhurst. *Proceedings, New England Railroad Club*, Dec., 1904. *Ry. Rev.*, Feb. 25, 1905.

Modern Shop Design. By A. Prengle. *Proceedings, Canadian Society of Civil Engineers*, Nov., 1903. *Ry. Rev.*, Jan., 1904.

A Plan for Maintaining Railroad Machinery. By M. K. Barnum. *Proceedings, Western Railway Club*, May, 1905. *Am. Eng.*, April, 1905.

Track Arrangements in Locomotive Shops. By C. A. Seley. *Am. Eng.*, June, 1904.

Method of Heating and Ventilating Roundhouses. *Proceedings, American Railway Master Mechanics' Association*, 1905.

Locomotive Terminal Facilities and Methods of Handling Car Scrap and Usable Material. *Proceedings, Master Car Builders' Association*, 1906.

Name of Periodical.	Abbreviation.
American Engineer and Railroad Journal.....	Am. Eng.
Engineering News	Eng. News
Engineering Record	Eng. Rec.
Locomotive Engineering	Loc. Eng.
Railroad Gazette	R. R. Gaz.
Railway Age	Ry. Age.
Railway Engineering and Maintenance of Way.....	Ry. Eng.
Railway Master Mechanic	Ry. M. M.
Railway and Engineering Review	Ry. Rev.

INDEX

Atchison, Topeka & Santa Fe Ry. at La Junta.	
blacksmith shop	80
oil house	184
roundhouse	213
storehouse	178
Atchison, Topeka & Santa Fe Ry. at Shopton.	
oil house	183
store house	183
Atchison, Topeka & Santa Fe Ry. at Topeka.	
blacksmith shop	81, 91
layout	14, 27, 56
power plant	150, 151, 158
Atlantic Coast Line Ry. at Waycross.	
cross section of roundhouse	216
Baltimore & Ohio R. R.	
ash pits	226
inspection pits	226
layout of locomotive terminal at Baltimore.....	206
layout of locomotive terminal at Holloway.....	206
layout of locomotive terminal at Washington.....	206
Big Four Ry. at Indianapolis.	
layout	16, 32
locomotive shop	63
Bibliography	235-238
Blacksmith shop	74-91
arrangement of equipment	77
blast	77
construction	75
crane service	75
doors for distribution of material.....	75
equipment lists	78-79
floor	75
fuel for furnaces	76
furnace equipment	77
hand forges	76
height from floor to roof truss.....	75
layout	74
location	11, 74
methods of operation	77
size	74
ventilation and light	76
Atchison, Topeka & Santa Fe Ry. at La Junta.....	80
Atchison, Topeka & Santa Fe Ry. at Topeka.....	81, 91
Buffalo, Rochester & Pittsburg Ry. at Du Bois.....	91
Canadian Pacific Ry. at Angus.....	83, 86
Chicago & Eastern Illinois Ry. at Danville.....	80
Chicago Great Western Ry. at Oelwein.....	87
Chicago, Milwaukee & St. Paul Ry. at Milwaukee.....	89
Chicago, Rock Island & Pacific Ry. at Silvis.....	82, 87
Delaware, Lackawanna & Western R. R. at Scranton.....	85, 90
Lake Shore & Michigan Southern Ry. at Collinwood.....	84, 88
Louisville & Nashville R. R. at South Louisville.....	83, 90
Pennsylvania R. R. at Olean.....	80, 86
Pennsylvania R. R. at Trenton.....	91
Philadelphia & Reading Ry. at Reading.....	88
Pittsburg & Lake Erie R. R. at McKees Rocks.....	84, 90
Terminal R. R. Assn. of St. Louis at E. St. Louis.....	87
Boiler shop (see Locomotive shop)	37
machine tools	50
Buffalo, Rochester & Pittsburg Ry. at Du Bois.	
blacksmith shop	91
layout	15, 25
locomotive shop	54
Canadian Pacific Ry. at Angus.	
blacksmith shop	83, 86
foundry	127, 131, 133
electrical distribution	49
freight car shop.....	94, 101
layout	15, 29
locomotive shop	58, 70, 71
passenger car shops	116
planing mill	125
power plant	154, 166, 167
scrap platform	189
storehouse	179
Central R. R. of New Jersey at Elizabethport.	
layout	18, 26
Chicago & Eastern Illinois Ry. at Danville.	
blacksmith shop	80
layout	18, 26
locomotive shop	55, 67
Chicago & Northwestern Ry. layout at Chicago.....	14
roundhouse at Clinton	209
Chicago & Western Indiana Ry. layout of locomotive terminal at Chicago	207
Chicago, Burlington & Quincy Ry. layout at Hannibal.....	24
Chicago Great Western Ry. at Oelwein.	
blacksmith shop	87
layout	23
locomotive shop	54, 66
planing mill	124
Chicago, Hamilton & Dayton R. R.	
cross section of engine house.....	216
Chicago, Milwaukee & St. Paul Ry. at Milwaukee.	
blacksmith shop	89
foundry (wheel)	132, 133
power plant	156, 163
Chicago, Rock Island & Pacific Ry. at Silvis	
blacksmith shop	82, 87
layout	18, 30
locomotive shop	60, 72, 73
power plant	155, 162
store house	179
Cleveland, Cincinnati, Chicago & St. Louis Ry. at Indianapolis.	
layout	16, 32
locomotive shop	63
Classification of railway shops.....	12
Colorado & Southern Ry. layout at Denver.....	24
Contents	3
Delaware & Hudson R. R. at Oneonta.	
cross section of roundhouse	211
drop pits	222, 223
layout of locomotive terminal	210
Delaware, Lackawanna & Western R. R. at Kingsland.	
passenger car and paint shop.....	111
Delaware, Lackawanna & Western R. R. at Scranton (car)	
blacksmith shop	85, 90
freight car shop	94, 102, 103
layout	20, 35
oil house	182, 183
planing mill	122, 125
Delaware, Lackawanna & Western R. R. at Scranton (locomotive).	
layout	33
locomotive shop	62
Denver & Rio Grande R. R. at Pueblo.	
cross section of roundhouse	215
plan of roundhouse	217
roundhouse pits	222
Electrical distribution, systems	45
alternating current	48
double commutator motors	47

multi-voltage	46	paint shop	114
speed variation by field control.....	48	passenger car shop	114
Electrical Equipment.		power plant	152, 153, 161
flexibility in general layout	10	scrap platform	181
El Paso & Southwestern Ry. at El Paso.		storehouse	190-194
cinder pits	227	Lake Shore & Michigan Southern Ry. at Elkhart.	
Erecting pits, number	38	boiler washing system	223
Erecting shop (see Locomotive shop)	38	cross section of roundhouse	214
Erie R. R.		layout at locomotive terminal.....	208
layout of locomotive terminal at Hammond.....	210	section of engine pit	223
standard roundhouse cross section	211	Layout	9-35
roundhouse plan	218	access to shops	9
Foundry	126-139	blacksmith shop	11
building, gray iron	126	classification of railway shops	12
charging floor	128	compactness provided by single transfer table.....	9
crane service	127	distribution of material	12
cupolas	128	electrical power in providing flexibility.....	10
disposition of work	128	evolution of old shops	13
industrial tracks	128	flexibility provided by electrical power.....	10
list of foundries at railway shops	126	foundry	11
location	11, 127	freight car shop	10
pattern shop	128	governing conditions	9
systems on Canadian Pacific Ry. at Angus.....	131	grouping of buildings	9
wheel	129	locomotive shop	10
wheel, Canadian Pacific Ry. at Angus.....	129	lumber yard	11
wheel, Chicago, Milwaukee & St. Paul Ry. at Milwaukee.....	129	passenger car shops	10
wheel, Pennsylvania R. R. at South Altoona.....	130	planing mill	11
Canadian Pacific Ry. at Angus.....	133	roundhouse	11
Chicago, Milwaukee & St. Paul Ry. at Milwaukee.....	132, 133	scrap department	11
Louisville & Nashville R. R. at South Louisville.....	134	storehouse	10
Philadelphia & Reading Ry. at Reading.....	135	Atchison, Topeka & Santa Fe Ry. at Topeka.....	14, 27, 56
Pennsylvania R. R. at South Altoona.....	136, 137, 138, 139	Big Four Railway at Indianapolis	16, 32
Freight car shop.....	92-106	Buffalo, Rochester & Pittsburg Ry. at Du Bois.....	15, 25
building	92	Canadian Pacific Ry. at Angus.....	15, 29
industrial tracks	93	Central R. R. of New Jersey at Elizabethport.....	18, 26
location	10, 92	Chicago & Eastern Illinois Ry. at Danville.....	18, 26
methods of operation	93	Chicago & Northwestern Ry. at Chicago.....	14
repair yards	98	Chicago, Burlington & Quincy Ry. at Hannibal.....	24
track arrangement	92	Chicago Great Western Ry., at Oelwein.....	23
Big Four Ry. at Indianapolis	97	Chicago, Rock Island & Pacific Ry. at Silvis.....	18, 30
Canadian Pacific Ry. at Angus.....	94, 101	Cleveland, Cincinnati, Chicago & St. Louis at Indian- apolis	16, 32
Cleveland, Cincinnati, Chicago & St. Louis Ry. at Indianapolis	97	Colorado & Southern Ry. at Denver.....	24
Delaware, Lackawanna & Western R. R. at Scranton..		Delaware, Lackawanna & Western R. R. at Scranton (car)	20, 35
.....	94, 102, 103	Delaware, Lackawanna & Western R. R. at Scranton (locomotive)	33
Illinois Central R. R. at Burnside.....	100, 102	Grand Trunk Ry. at Battle Creek	33
Louisville & Nashville R. R. at South Louisville.....	96, 103, 104	Illinois Central R. R. at Burnside.....	13
New York, New Haven & Hartford R. R. at Readville..	96	Lake Shore & Michigan Southern Ry. at Collinwood....	28
Pittsburg & Lake Erie R. R. at McKees Rocks.....		Louisville & Nashville R. R. at South Louisville.....	17, 31
.....	97, 100, 105, 106	Missouri, Kansas & Texas Ry. at Sedalia.....	34
St. Louis, Iron Mountain & Southern Ry. at Baring Cross	101	New York, New Haven & Hartford R. R. at Readville.....	19, 34
Wabash R. R. at East Decatur.....	97	Philadelphia, Baltimore & Wilmington R. R. at Wil- mington	29
Wisconsin Central Ry. at Fond du Lac.....	100, 102	Pittsburg & Lake Erie R. R. at McKees Rocks.....	15, 25
Grand Trunk Ry. at Battle Creek.		St. Louis, Iron Mt. & Southern Ry. at Baring Cross....	23
layout	33	Wabash R. R. at East Decatur.....	21, 35
locomotive shop	62	Lehigh Valley R. R. locomotive shop at Sayre.....	59, 69
Great Northern Ry. scrap platform at St. Paul.....	181	Louisville & Nashville R. R. at South Louisville.	
Illinois Central R. R. at Burnside.		blacksmith shop	83, 90
freight car shop	100, 102	foundry	134
layout	13	freight car shop	92, 102, 103
paint shop	113	layout	17, 31
planing mill	123	locomotive shop	61, 69
storehouse	180	passenger car shop	112
Introductory	7	planing mill	121, 122
Lake Shore & Michigan Southern Ry. at Collinwood.		power plant	156
blacksmith shop	84, 88	Locomotive shop	36-73
layout	28	aisle space	43
layout at locomotive terminal	209	alternating current system	48
locomotive shop	57		
oil house	184		

- arrangement of erecting pits 38
 area of erecting floor 42
 area of machine floor 42
 boiler department 37
 building 36
 double commutator motors 47
 electrical distribution 45
 electrical distribution at Angus, C. P. Ry. 49
 erecting bay, width 40
 erecting floor, area 42
 erecting floor, proportion of area to machine floor..... 42
 erecting pits, arrangement 38
 erecting pits, number 38
 equipment lists 65, 66, 68, 70, 71, 72, 73
 floor space per machine 43
 grouping of machines 43
 location in general layout 10
 location of boiler department 37
 machine bay 41
 machine floor, area 42
 machine floor, proportion of area to erecting floor..... 42
 machine floor space 43
 machine grouping 43
 machine tool equipment 51
 machine too's, number 50
 multi-voltage system 46
 number of erecting pits 38
 number of machine tools 50
 proportion of departments 37
 relative areas of erecting and machine floors..... 42
 sanitary requirements 45
 size 40
 speed variation obtained by field control..... 48
 storage of dismantled parts 44
 storage of locomotive skeletons 38
 systems of electrical distribution 45
 width of erecting bay 40
 Atchison, Topeka & Santa Fe Ry. at Topeka..... 56
 Big Four Ry. at Indianapolis..... 63
 Buffalo, Rochester & Pittsburg Ry. at Du Bois..... 54
 Canadian Pacific Ry. at Angus..... 58, 70, 71
 Chicago & Eastern Illinois R. R. at Danville..... 55, 67
 Chicago Great Western Ry. at Oelwein..... 54, 66
 Chicago, Rock Island & Pacific Ry. at Silvis..... 60, 72, 73
 Cleveland, Cincinnati, Chicago & St. Louis Ry. at Indian-
 apolis 63
 Delaware, Lackawanna & Western R. R. at Scranton.... 62
 Grand Trunk Ry. at Battle Creek..... 62
 Lake Shore & Michigan Southern Ry. at Collinwood.... 57
 Lehigh Valley R. R. at Sayre..... 59, 69
 Louisville & Nashville R. R. at South Louisville..... 61, 69
 Pere Marquette R. R. at Grand Rapids..... 57, 65
 Pittsburg & Lake Erie R. R. at McKees Rocks..... 55, 68
 St. Louis, Iron Mountain & Southern Ry. at Baring
 Cross 54, 64
 Terminal R. R. Assn. of St. Louis, at E. St. Louis.... 56, 65
 Union Pacific R. R. at Omaha..... 55
 Lumber yard.
 location in general layout..... 11
 Machine shop (see Locomotive shop)..... 41
 Machine tool equipment for the locomotive shop.
 machine tools for 1, 12, 15, 24, 48 erecting pits.....
 51-53, 65, 66, 68, 70-73
 boring mills 51-53
 drills 51-53
 grinders 51-53
 lathes 51-53
 millers 51-53
 miscellaneous 51-53
 planers 51-53
 shapers 51-53
 slotters 51-53
 Missouri, Kansas & Texas Ry. roundhouse heating system
 at Parsons 219
 layout at Sedalia 34
 Missouri Pacific Ry. at Sedalia.
 passenger car and paint shop..... 111
 planing mill 122
 New York Central & Hudson River R. R. at West Albany.
 scrap platform 196
 storehouse 195
 New York Central & Hudson River R. R. at De Witt.
 layout of locomotive terminal..... 205
 New York, New Haven & Hartford R. R. layout at Read-
 ville 19, 34
 New York, Ontario & Western Ry. at Middletown.
 heating system in roundhouse..... 218
 paint shop 110, 116
 Oil house 175
 building 176
 delivery 176
 location 175
 Atchison, Topeka & Santa Fe Ry. at La Junta..... 184
 Atchison, Topeka & Santa Fe Ry. at Shopton..... 183
 Delaware, Lackawanna & Western R. R. at Scranton. 182, 183
 Lake Shore & Michigan Southern Ry. at Collinwood.... 184
 Paint manufacture 109
 Passenger car shops 107-116
 Passenger coach and paint shops..... 107-116
 building 107
 fire protection 109
 floor 109
 location 10, 107
 natural lighting 107
 scaffolds 109
 track arrangement 107
 transfer table operation 108
 transfer table service 108
 truck repairs 109
 Canadian Pacific Ry. at Angus..... 116
 Delaware, Lackawanna & Western R. R. at Kingsland... 111
 Illinois Central R. R. at Burnside..... 113
 Lake Shore & Michigan Southern Ry. at Collinwood... 114
 Louisville & Nashville R. R. at South Louisville..... 112
 Missouri Pacific Ry. at Sedalia..... 111
 New York, Ontario & Western Ry. at Middletown. 110, 116
 Pittsburg & Lake Erie R. R. at McKees Rocks..... 109, 115
 Seaboard Air Line Ry. at Portsmouth..... 109
 Wabash R. R. at East Decatur 112
 Pattern shop 128, 135
 Pennsylvania R. R. at East Altoona.
 coaling station 230
 cross section of roundhouse..... 214
 details of engine pits and roundhouse floor..... 220
 drop pits 221, 222
 inspection pits 225
 layout at locomotive terminal..... 205
 pneumatic coal chute gate 231
 pneumatic lifting door in roundhouse..... 222
 sand drying and storage plant 231
 track stop 222
 Pennsylvania R. R. at Olean.
 blacksmith shop 80, 86
 Pennsylvania R. R. at South Altoona.
 foundries 136, 139
 Pennsylvania R. R. at Trenton.
 blacksmith shop 91
 Pere Marquette R. R. at Grand Rapids.
 coaling station 233, 234
 cross section of engine house..... 216

locomotive shop	57, 65	Preface	5
Philadelphia & Reading Ry. at Reading.		References to articles descriptive of railway shops.....	235-238
blacksmith shop	88	Roundhouse	197-234
coaling station	227	ash pits	225, 226, 227
foundry	135	boiler washing systems	203, 223, 224
power plant	152, 162	cinder pit	199, 225, 226, 227
Philadelphia, Baltimore & Wilmington R. R. layout at Wil-		coaling station	198, 227-234
mington	29	construction	199
Pittsburg & Lake Erie R. R. at McKees Rocks.		crane service	202
blacksmith shop	84, 90	cross section	200, 211, 216
boiler washing system	224	cross section, A. T. & S. F. Ry. at La Junta.....	213
coaling station	228, 229	cross section, A. C. L. R. R. at Waycross.....	216
cross section of roundhouse	212	cross section, B. & O., Standard.....	211
freight car shop	97, 100, 105, 106	cross section, C. H. & D. R. R.....	216
layout	15, 25	cross section, D. & H. R. R. at Oneonta.....	211
locomotive shop	55, 68	cross section, D. & R. G. R. R. at Pueblo.....	215
paint shop	109, 115	cross section, Erie R. R., Standard.....	211
power plant	149, 159, 165	cross section, L. S. & M. S. Ry. at Elkhart.....	214
sand handling station	230	cross section, P. R. R. at East Altoona.....	214
Planing mill	117-125	cross section, Pere Marquette R. R. at Grand Rapids....	216
arrangement of machines	118	cross section, P. & L. E. R. R. at McKees Rocks.....	212
building	117	cross section, Southern Ry. at Inman Yard.....	212
distribution of material	118	cross section, Terminal R. R. Assn. of St. Louis at East	
equipment lists	119-121	St. Louis	213
floors	118	cross section, Wabash R. R. at Landers.....	212
location	11, 117	doors	201, 222
machine arrangement	118	drop pits	221, 222, 223
natural lighting	117	engine house, rectangular	209, 216
shavings exhaust systems	118	engine pits	220
Canadian Pacific Ry. at Angus	125	floors	202
Chicago Great Western Ry. at Oelwein.....	124	heating	201
Delaware, Lackawanna & Western R. R. at Kingsland.....	124	heating system, M. K. & T. Ry. at Parsons.....	219
Delaware, Lackawanna & Western R. R. at Scranton.....	122, 125	heating system, N. Y. O. & W. Ry. at Middletown.....	218
Illinois Central R. R. at Burnside.....	123	heating system, P. R. R. at East Altoona.....	218
Louisville & Nashville R. R. at South Louisville.....	121, 122	inspection pit	199, 225, 226
Missouri Pacific Ry. at Sedalia.....	122	layout	197, 205, 210
Wabash R. R. at East Decatur.....	123, 124	layout, B. & O. R. R. at Baltimore.....	206
Power plant	140-169	layout, B. & O. R. R. at Holloway.....	206
boilers	144	layout, B. & O. R. R. at Washington.....	206
boiler pressure.....	144	layout, C. & N. W. Ry. at Clinton.....	209
building	140	layout, C. & W. I. Ry. at Chicago.....	207
chimneys	144	layout, D. & H. R. R. at Oneonta.....	210
coal and ash handling equipment.....	141-144	layout, Erie R. R. at Hammond.....	210
data	148	layout, L. S. & M. S. Ry. at Collinwood.....	209
diagrams of power distribution.....	165-169	layout, L. S. & M. S. at Elkhart.....	208
distribution of electric power.....	147	layout, N. Y. C. & H. R. R. R. at DeWitt.....	205
draft systems	145, 146	layout, P. R. R. at East Altoona.....	205
economizers	146	layout, Southern Ry. at Inman Yard.....	207
electric current	147	layout, Terminal R. R. Assn. of St. Louis at St. Louis....	209
engine equipment	146	lighting	200
gas engines	147	location	11
location	140	piping	203
mechanical draft	145	pits	201, 220, 222, 223
piping	146	plan, B. & O. R. R.....	217
steam turbines	146	plan, D. & R. G. R. R. at Pueblo.....	217
stokers	144	plan, Erie R. R.	218
turbine	146	plan, Southern Ry. at Atlanta.....	217
Atchison, Topeka & Santa Fe Ry. at Topeka.....	150, 151, 158	sand house	198
Canadian Pacific Ry. at Angus.....	154, 166, 167	sand plant	230, 231, 233, 234
Chicago & Eastern Illinois R. R. at Danville.....	150, 160, 168	smoke jacks	203
Chicago, Milwaukee & St. Paul Ry. at Milwaukee.....	156, 163	stand pipe	199
Chicago, Rock Island & Pacific Ry. at Silvis.....	155, 162	storage tracks	199
Lake Shore & Michigan Southern Ry. at Collin-		track stop	203, 222
wood	152, 153, 161	turntable	199
Louisville & Nashville R. R. at South Louisville.....	156	ventilation	201
Pennsylvania R. R. at Olean.....	157, 164	St. Louis, Iron Mountain & Southern Ry. at Baring Cross.	
Pere Marquette R. R. at Grand Rapids.....	157, 164, 169	freight car shop	101
Philadelphia & Reading Ry. at Reading.....	152, 162	locomotive shop	54, 64
Pittsburg & Lake Erie R. R. at McKees Rocks.....	149, 159, 165	power plant	149, 158
St. Louis, Iron Mountain & Southern Ry. at Baring		Scrap	173, 181, 189, 196
Cross	149, 158		

Scrap department.	
location in general layout.....	11
Scrap platform.	
Canadian Pacific Ry. at Angus.....	189
Great Northern Ry. at St. Paul.....	181
Lake Shore & Michigan Southern Ry. at Collinwood....	181
New York Central & Hudson River R. R. at W. Albany..	196
Seaboard Air Line Ry. at Portsmouth.	
passenger car shop	109
Southern Ry.	
cinder pits	227
coaling plant at Inman Yard.....	228
cross section of roundhouse at Inman Yard.....	212
engine pits	220
layout at Inman Yard.....	207
Storehouse	170-196
bolster storage	189
bolt storage	186
bolt transportation.....	192
brass room	185
building	171
car casting bins.....	187
crane service	173, 185, 189, 196
interior arrangement	172
iron storage	186, 189
location	10, 171
lumber storage	188
paint stock	193
platform served by crane.....	185
rack for storing tubes.....	185
rod storage	186
scrap	173
shelves, unit system.....	190, 191
transportation of material.....	185, 187, 192
wheel storage	188
turn table for distribution tracks.....	185
Atchison, Topeka & Santa Fe Ry. at LaJunta.....	178
Atchison, Topeka & Santa Fe Ry. at Shopton.....	183
Canadian Pacific Ry. at Angus.....	179
Chicago, Rock Island & Pacific Ry. at Silvis.....	179
Illinois Central R. R. at Burnside.....	180
Lake Shore & Michigan Southern Ry. at Collinwood.....	190-194
New York Central & Hudson River R. R. at West Albany..	195
St. Louis, Iron Mountain & Southern Ry. at Baring Cross..	177
Terminal R. R. Assn. of St. Louis, at East St. Louis.....	179
Union Pacific Ry. at Omaha.....	180
Wabash R. R. at East Decatur.....	177
Terminal R. R. Assn. of St. Louis at East St. Louis	
blacksmith shop	87
cross section of roundhouse.....	213
locomotive shop	56, 65
storehouse	179
Terminal R. R. Assn. of St. Louis at St. Louis	
coaling station	232
layout of locomotive terminal.....	209
Transfer table	
access to shops.....	9
compactness provided	9
effect on layout.....	9
Union Pacific R. R. at Omaha	
locomotive shop	55
storehouse	180
Wabash R. R. at East Decatur	
freight car shop.....	97
layout	21, 35
passenger car shop	112
planing mill	123, 124
Wabash R. R. at Landers	
cross section of roundhouse.....	212
Wisconsin Central Ry. at Fond du Lac	
freight car shop	100, 102

Index to Advertisers

Acme Machinery Co., The	48	Landis Tool Co.	48
Ajax Mfg. Co., The	38	Lucas & Co., John	24
American Balance Valve Co.	21	Macleod & Co., Walter	9
American Valve & Meter Co.	22	Marston Co., J. M.	64
Armstrong Bros. Tool Co.	7	McConway & Torley Co., The	58
Armstrong Mfg. Co., The	48	McCord & Co.	60
Baldwin Steel Co.	70	McCroskey Mfg. Co., The F. B.	49
Baeder, Adamson & Co.	29	McInnes Steel Co., Ltd.	25
Becker-Brainard Milling Machine Company.....	74	McKim & Co., John	28
Beckwith-Chandler Co.	29	Merrell Mfg. Co., The.....	49
Bentel & Margedant Co.	29	Metal Plated Car & Lumber Co.	20
Best American Calorific Company, W. N.	71	Milton Manufacturing Co.	20
Bettendorf Axle Co.	61	Nathan Manufacturing Co.	18
Bowser, S. F. & Co., Inc.	65	National Machinery Co., The	46
Buffalo Brake Beam Co.	18	National Malleable Castings Co.	11
Bullard Machine Tool Co., The	80	National Oil Pump & Tank Co.	78
Case Mfg. Co., The.....	48	New Jersey Zinc Co., The	15
Chambersburg Engineering Co.	46	Nicholson File Co.	13
Chester Steel Castings Co.	63	Nichols, Geo. P., & Bro.....	17
Cincinnati Punch & Shear Co., The	45	Parrott Varnish Co.	12
Cleanola Co., The	11	Parkhurst & Wilkinson Co.	55
Cleveland City Forge & Iron Co.	39	Pittsburg Crushed Steel Co.....	6
Cleveland Punch & Shear Works Co., The.....	69	Pittsburg Spring & Steel Co.	49
Coates Clipper Mfg. Company	78	Prentiss Tool & Supply Co.	76
Coes Wrench Co.	47	Purchasing Agents' Buying List	72
Columbia Nut & Bolt Co., Inc.	63	Queen City Machine Tool Co.	12
Cooper Hewitt Electric Co.	64	Railway Master Mechanic	75
Crandall Publishing Co.	79	Railway Materials Co. The	9-11-12-17-18-28-63-78
Crockett Co., The David B.	10	Ralston Steel Car Co., The	59
Detroit Graphite Mfg. Co.	23	Rockwell Engineering Co.	77
Diamond Saw & Stamping Works	66	Ronceray, E.	20
Drake & Wiers Co.	63	St. Louis Surfacers & Paint Co.	67
Duff Manufacturing Co.	16	Safety Car Heating & Lighting Co., The	57
Ellis-Chalmers Co.	29	Sellers, William & Co., Inc.	41
Faessler Mfg. Co., J.	61	Sight Feed Oil Pump Co.	18
Farlow Draft Gear Co.	11	Slocomb & Co., F. F., Inc.	17
Flannery Bolt Co.	59	Smith Machine Co., H. B.	51
Foote-Burt Co., The	34-35-36-37	Smith Foundry Supply Co., J. D.	9
Franklin Manufacturing Co.	56	Standard Tool Co., The	20-24-26-28
Galena-Signal Oil Co.....	64	Starrett Co., L. S.	44
Garvin Machine Co., The	40	Stockbridge Machine Co.	42
Geometric Tool Co., The	43	Stoeber Foundry & Mfg. Co.	8
Globe Ventilator Co.	13	Stowell Mfg. Co.	54
Gould Coupler Co.	52	Underwood & Co., H. B.	49
Gould Storage Battery Co.	53	Vanduzen Co., The E. W.	73
GreenJee Bros. & Co.	50	Van Nostrand Co., D.	27
Hanna Mfg. Co., The	19	Vulcan Iron Works	60
Heath & Milligan Mfg. Co.	13	Warner & Swasey Co., The	30-31-32-33
Henderer's Sons, A. L.....	17	Watson-Stillman Co., The	19
Holmes Metallic Packing Co.	29	Wells Light Mfg. Co.	11
Homestead Valve Mfg. Co.	63	Western Tool & Mfg. Co.	17
Indianapolis Switch & Frog Co., The	64	Whiting Foundry Equipment Co.....	68
Jefferson Union Co.	62	Williams Tool Co.	12
Kolesch & Co.	11	Wolfe Brush Co.	13
Landis Machine Co.	22		

WE PUBLISH

Railway Master Mechanic

Railway Shop Up To Date

Modern Machinery

Railway Engineering

Purchasing Agents Buying List

Covering the Railway and
Machinery Manufacturing Field

Crandall Publishing Co.

CHICAGO: 510 Security Bldg.

NEW YORK: 132 Nassau St.

Subscription and Advertising Rates on Request.

DIAMOND STEEL EMERY For Grinding Steam and
Air Joints
CUTS BUT
NEVER BREAKS
A RAILROAD SHOP NECESSITY
PITTSBURGH CRUSHED STEEL CO., Pittsburgh, Pa.

Buyers' Guide

Abrasives.

Baeder, Adamson & Co., Philadelphia, Pa.
Pittsburg Crushed Steel Co., Pittsburg, Pa.

Acetylene Headlights.

Macleod & Co., Walter, Cincinnati, O.

Acetylene Torches for Outdoor Work.

Macleod & Co., Walter, Cincinnati, O.

Accumulators, Hydraulic.

Watson-Stillman Co., New York.

Adjustable Reamers.

McCrosky, F. B. Mfg. Co., Meadville, Pa.

Air Hoists.

Whiting Foundry Equipment Co., Harvey, Ill.

Air Compressors.

Air Hose Couplers.

Safety Car Htg. & Ltg. Co., New York.

Arch Bar Drill Presses.

Foote-Burt Co., Cleveland, O.

Architects and Draftsmen's Supplies.

Kolesch & Co., New York.

Asbestos Coverings and Supplies.

Franklin Mfg. Co., Franklin, Pa.

Asbestos Roofing Slates.

Franklin Mfg. Co., Franklin, Pa.

Asbestos Sheathing.

Franklin Mfg. Co., Franklin, Pa.

Asphalt Roofing.

Stowell Mfg. Co., Jersey City, N. J.

Automatic Gear Cutting Machines.

Becker-Brainard Milling Machine Co., Hyde Park, Mass.

Automatic Pin Drilling Machines.

Ajax Mfg. Co., Cleveland, O.

Automatic Water Columns.

American Valve & Meter Co., Cincinnati, O.

Axles.

Ajax Mfg. Co., Cleveland, O.

Cleveland City Forge & Iron Co., Cleveland, O.

Gould Coupler Co., New York.

McInnes Steel Co., Corry, Pa.

Axle Lathes.

Sellers & Co., Wm., Philadelphia, Pa.

Axle Machines.

Ajax Mfg. Co., Cleveland, O.

Axle Straighteners.

Watson-Stillman Co., New York, N. Y.

Babbitt Metals.

Vanduzen Co., E. W., Cincinnati, O.

Balance Main Valves.

American Balance Valve Co., Jersey Shore, Pa.

Band Saws.

American Wood Working Machine Co., New York.

Bentel & Margedant Co., Hamilton, O.

Marston Co., J. M., Boston, Mass.

Smith, H. B., Machine Co., Smithville, N. J.

Batteries, Storage, for Train Lighting.

Gould Storage Battery Co., New York.

Bending, Boiler & Straightening Rolls.

Cincinnati Punch & Shear Co., Cincinnati, O.

Sellers & Co., Wm., Philadelphia, Pa.

Blow-off Valves.

Homestead Valve Mfg. Co., Pittsburg, Pa.

Blue Print Papers.

Kolesch & Co., New York.

Boiler Lagging.

Franklin Mfg. Co., Franklin, Pa.

Boiler Makers Tools.

Cincinnati Punch & Shear Co., Cincinnati, O.

Cleveland Punch & Shear Works Co., Cleveland, O.

Boiler Rolls.

Cincinnati Punch & Shear Co., Cincinnati, O.

Boiler & Pipe Coverings.

Franklin Mfg. Co., Franklin, Pa.

Bolsters—Truck and Body.

Bettendorf Axle Co., Davenport, Ia.

Bolts and Nuts.

Columbia Nut & Bolt Co., Inc., Bridgeport, Conn.

Milton Mfg. Co., Milton, Pa.

Bolt Cutters and Headers.

Acme Machinery Co., Cleveland, O.

Ajax Mfg. Co., Cleveland, O.

Foote-Burt Co., Cleveland, O.

Landis Mach. Co., Waynesboro, Pa.

National Machinery Co., Tiffin, O.

Sellers & Co., William, Philadelphia, Pa.

Bolt Drivers.

Armstrong Bros. Tool Co., Chicago.

Bolt Forging Machines.

Acme Machinery Co., Cleveland, O.

Ajax Mfg. Co., Cleveland, O.

National Machinery Co., Tiffin, O.

Bolt Pointing Machines.

Acme Machinery Co., Cleveland, O.

Foote-Burt Co., Cleveland, O.

The National Machinery Co., Tiffin, O.

ARMSTRONG TOOL HOLDERS

will do more work and cause less trouble than any other tools you can put on your lathes and planers. Experience counts in making tool holders just as it does in any other line, yours for instance. It's easy for us to make better tool holders than anybody else; that's been our specialty for years, and it don't cost us (or you) one cent extra.

WE MAKE A COMPLETE LINE—A Tool Holder for Every Operation on the Lathe and Planer

Cutter is Extra Large and is supported directly under strain of cut.
Our Patented Relieved Seat prevents chattering and breaking of cutter.

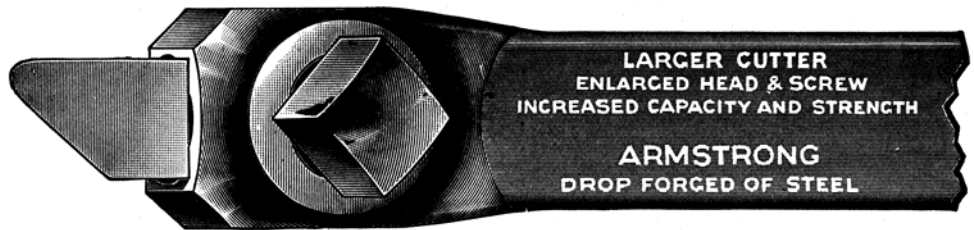

Patented February 28, 1893, and patent pending

Armstrong Universal Ratchet Drill

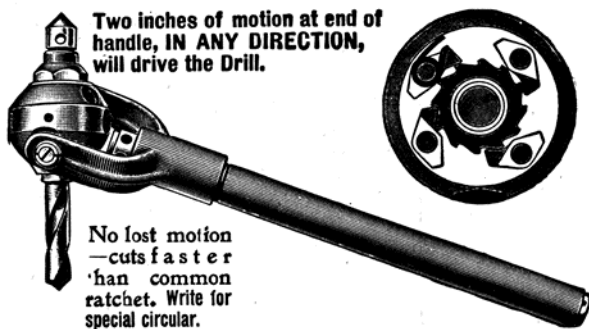

A Few of These Ratchets

in your erecting and repair department will repay their cost many times in the course of a year. They have a special field of their own in which neither air or electric drills nor the common ratchet can compete.

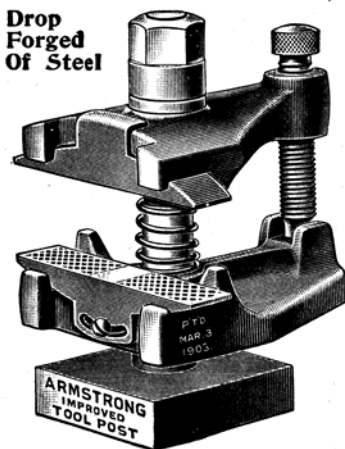

The Armstrong Improved Tool Post

FOUR SIZES
 OUR improved Tool Post combines in itself the strength and holding power of the Strap and Stub Tool Clamp with the convenience of the "open side" and ordinary Set Screw Tool Post. Write for special circular.

3-Bar Boring Tool

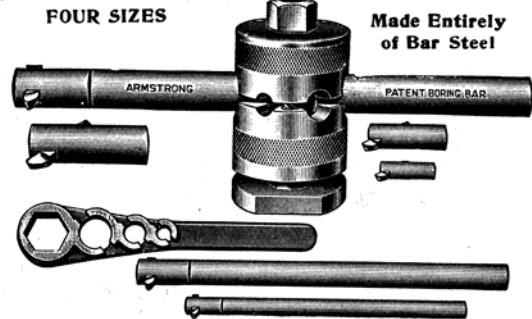

Increases production and reduces cost of tool maintenance. Cutters cannot jar loose. High Speeds and Big Feeds only set them tighter. Write for special circular.

Do you want our catalog? It's A Tool Holder Encyclopedia.

Armstrong Bros. Tool Co.

129 N. Francisco Ave., Chicago, U. S. A.

"The Tool Holder People."

IMITATIONS ARE UNSATISFACTORY—INFRINGEMENTS ARE UNLAWFUL

PIPE THREADING MACHINES

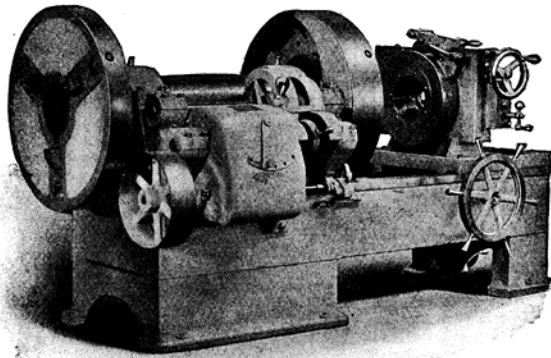

This cut shows the No. 6 machine which threads and cuts off from $1\frac{1}{4}$ in. to 6 in. It has ten speeds, two gripping chucks, sliding head, steel clad die head and other improvements.

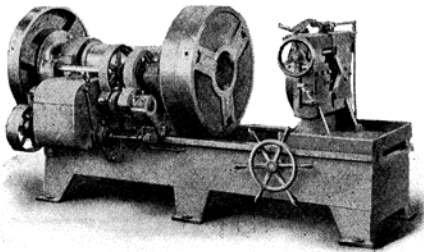

We have a complete line of machines for threading all sizes of pipe from $\frac{1}{4}$ to 12 inches. Each machine was designed with the idea of getting the work out rapidly, with as little wear as possible. Hence we use hardened steel instead of cast iron in many places. To get the work out we give a large number of speeds.

Our booklet explains matters clearly. Send for it.

The Stoever Foundry & Mfg. Co.

MYERSTOWN, PA.

BUYERS' GUIDE—Continued.

- Bolt Threading Machines.**
Acme Machinery Co., Cleveland, O.
Foote-Burt Co., Cleveland, O.
Williams Tool Co., Erie, Pa.
- Books.**
D. Van Nostrand Co., New York.
- Boring Mills.**
Bullard Machine Tool Co., Bridgeport, Conn.
Prentiss Tool & Supply Co., New York.
Sellers & Co., Wm., Philadelphia, Pa.
- Boring Machines, Metal.**
Foote-Burt Co., Cleveland, O.
- Boring Machines, Wood.**
American Wood Working Machinery Co., New York.
Bentel & Margedant Co., Hamilton, O.
Greenlee Bros. & Co., Chicago.
- Boring Tools.**
Armstrong Bros Tool Co., Chicago, Ill.
Western Tool & Mfg. Co., Springfield, O.
- Brake Beams.**
Buffalo Brake Beam Co., Buffalo, N. Y.
- Brake Jaws.**
Cleveland City Forge & Iron Co., Cleveland, O.
- Brake Shoes.**
Railway Materials Co., Chicago.
W. M. Simpson, Chicago.
- Brass Castings.**
Homestead Valve Mfg. Co., Pittsburg, Pa.
- Brass Founders.**
Homestead Valve Mfg. Co., Pittsburg, Pa.
- Brass Foundry Equipment.**
Whiting Foundry Equipment Co., Harvey, Ill.
- Brass Working Machinery.**
Warner & Swasey Co., Cleveland, O.
- Bridge Paint.**
Detroit Graphite Mfg. Co., Detroit, Mich.
Heath & Milligan Mfg. Co., Chicago.
Lucas & Co., John, Philadelphia, Pa.
St. Louis Surface & Paint Co., St. Louis, Mo.
Stowell Mfg. Co., Jersey City, N. J.
- Brushes, Paint.**
McKim, John & Co., Philadelphia, Pa.
Wolfe Brush Co., Pittsburg, Pa.
- Building Felts and Papers.**
Franklin Mfg. Co., Franklin, Pa.
- Bulldozers and Bending Machines.**
Ajax Mfg. Co., Cleveland, O.
National Machinery Co., Tiffin, O.
- Bumping Posts.**
McCord & Co., Chicago.
- Canvas Paints.**
Detroit Graphite Mfg. Co., Detroit, Mich.
Heath & Milligan Mfg. Co., Chicago.
Lucas Co., John, Philadelphia, Pa.
St. Louis Surfacer & Paint Co., St. Louis, Mo.
- Car Axles.**
Cleveland City Forge & Iron Co., Cleveland, O.
Gould Coupler Co., New York.
- Car Bolsters.**
Bettendorf Axle Co., Davenport, Ia.
- Car Cleaner.**
Cleanola Co., Allegheny, Pa.
- Car Cleaning Brushes.**
McKim & Co., John, Philadelphia, Pa.
- Car Couplers.**
Gould Coupler Co., New York.
McConway & Torley Co., Pittsburg, Pa.
National Malleable Castings Co., Cleveland, O.
- Car Forgings.**
Cleveland City Forge & Iron Co., Cleveland, O.
- Car Gaining Machines.**
(See Woodworking Machinery.)
- Car Heating and Car Heaters.**
Gold Car Heating & Lighting Co., New York.
Safety Car Heating & Lighting Co., New York.
- Car Lamps.**
Safety Car Heating & Lighting Co., New York.
- Car Lighting.**
Gould Coupler Co., New York.
Safety Car Heating & Lighting Co., New York.
- Car Lighting Storage Batteries.**
Gould Storage Battery Co., New York.
- Car Paints.**
See Paints.
- Car Roofing.**
Drake & Wiers Co., Cleveland, O.
- Car Shop Machinery.**
American Wood Working Machinery Co., New York.
Bentel & Margedant Co., Hamilton, O.
Greenlee Bros. & Co., Chicago.
Smith, H. B. Machine Co., Smithville, N. J.

FERGUSON OIL FURNACES

Chicago

The Railway Materials Company

New York

OUR 500 X PLUMBAGO



Is refined and ground at our Cleveland Facing mill, from the best grade of Ceylon Graphite.

It is ground very fine and has a brilliant silver polish. Can be applied with a brush or shake bag and slicked with the hand or tool. Gives a nice blue color to the castings, and peels them perfectly clean.

We will send a pound sample for trial free of all charges. Send for No. 37 Catalogue.

The J. D. SMITH FOUNDRY SUPPLY CO.
CLEVELAND, OHIO.

WE DESIGN AND BUILD COMPLETE FOUNDRY PLANTS

F. H. CHAMBERLIN, Prest.-Mgr.

J. S. SMITH, Sec'y.-Treas.

F. A. COLEMAN, Engineer.

OIL-RIVET FORGE

THE BUCKEYE LOCO TIRE EXPANDER.

PAINTING & WHITEWASHING MACHINE.

WALTER MACLEOD & CO.
MANUFACTURERS OF
THE BUCKEYE LIGHT AND HEATER.
OIL BURNER SPECIALTIES AND FORGES, SAND BLASTS,
PAINTING AND WHITEWASHING MACHINES, ETC.

SAND BLAST.

BUCKEYE LIGHT
CODES A. B. C. LIEBERS.

THE BUCKEYE BOILER.

213 East Pearl Street,

CINCINNATI, OHIO.

BUYERS' GUIDE—Continued.

- Car Springs.**
Pittsburg Spring & Steel Co., Pittsburg, Pa.
- Car Trucks.**
Bettendorf Axle Co., Davenport, Ia.
- Car Ventilation.**
Safety Car Heating & Lighting Co., New York.
- Car Wheels.**
Vulcan Iron Works, Wilkes Barre, Pa.
- Car Wheel and Crank Pin Presses.**
Watson-Stillman Co., New York.
- Cars.**
Bettendorf Axle Co., Davenport, Ia.
Ralston Steel Car Co., Columbus, O.
- Cars, Dump, Ballast, etc.**
Ralston Steel Car Co., Columbus, O.
- Cars, Steel.**
Bettendorf Axle Co., Davenport, Ia.
- Cars, Tank.**
Bettendorf Axle Co., Davenport, Ia.
- Car Wheel Plants.**
Whiting Foundry Equipment Co., Harvey, Ill.
- Car Window Strips, Metallic.**
Metal Plated Car & Lumber Co., New York.
- Castings, Brass.**
Homestead Valve Mfg. Co., Pittsburgh, Pa.
- Castings, Railway.**
Chester Steel Castings Co., Phila., Pa.
Gould Coupler Co., New York.
National Malleable Castings Co., Cleveland, O.
Vulcan Iron Works, Wilkes Barre, Pa.
- Castings, Malleable Iron.**
Gould Coupler Co., New York.
National Malleable Castings Co., Cleveland, O.
- Chucks, Drill.**
Standard Tool Co., Cleveland, O.
- Clamping Machines.**
American Wood Working Machinery Co., New York.
Smith, H. B. Mach Co., Smithville, N. J.
- Cleaners and Polishing Compound.**
Cleanola Co., Allegheny, Pa.
- Clevis Nuts.**
Cleveland City Forge & Iron Co., Cleveland, O.
- Coach Roof Paints.**
St. Louis Surfacers & Paint Co., St. Louis, Mo.
- Cock Grinders.**
Warner & Swasey Co., Cleveland, O.
- Cold Water Calcimine.**
Lucas & Co., John, Philadelphia, Pa.
- Cold Water Paints.**
Lucas & Co., John, Philadelphia, Pa.
- Colors.**
Heath & Milligan Mfg. Co., Chicago.
Lucas & Co., John, Philadelphia, Pa.
- Combination Tap and Drill.**
Standard Tool Co., Cleveland, O.
- Continuous Platform and Buffers.**
Gould Coupler Co., New York.
- Contractors' Equipment and Supplies.**
Vulcan Iron Works, Wilkes Barre, Pa.
- Contractors' Light.**
Macleod & Co., Walter, Cincinnati, O.
Wells Light Mfg. Co., New York.
- Contractors' Locomotives.**
Vulcan Iron Works, Wilkes Barre, Pa.
- Core Ovens.**
Smith, J. D., Foundry Supply Co., Cleveland, O.
- Couplers, Car.**
Gould Coupler Co., New York.
McConway & Torley Co., Pittsburg.
National Malleable Castings Co., Cleveland.
- Couplers, Pilot.**
Gould Coupler Co., New York.
- Cranes, Hand, Steam, Electric.**
Whiting Foundry Equipment Co., Harvey, Ill.
Case Mfg. Co., Columbus, O.
Sellers & Co., Wm., Philadelphia, Pa.
- Crank Pin Presses.**
Watson-Stillman Co., New York.
- Crank Pin Turner.**
Underwood, H. B., & Co., Philadelphia, Pa.
- Crucibles.**
Smith, J. D., Foundry Supply Co., Cleveland, O.
- Crucible Tool Steel.**
McInnis Steel Co., Corry, Pa.
- Crushed Steel.**
Pittsburg Crushed Steel Co., Pittsburg, Pa.
- Cupolas and Cupola Blocks.**
Smith, J. D., Foundry Supply Co., Cleveland, O.
- Curled Hair.**
Baeder, Adamson & Co., Philadelphia, Pa.
- Cutting-Off Saws.**
Bentel & Margedant Co., Hamilton, O.
Smith, H. B. Mach. Co., Smithville, N. J.
- Cutting-Off Tools.**
Armstrong Bros. Tool Co., Chicago, Ill.
- Cutters, Milling.**
Standard Tool Co., Cleveland, O.
- Cutting-Off Machine for Self-Hardening Steel.**
Armstrong Bros. Tool Co., Chicago.
- Cylinder Packing.**
Franklin Mfg. Co., Franklin, Pa.
- Dado or Grooving Heads.**
American Wood Working Machinery Co., New York.
Bentel & Margedant Co., Hamilton, O.
- Depot and Station Paints—(See Paints).**
- Die Heads, Adjustable, Self-Opening.**
Geometric Tool Co., New Haven, Conn.
- Die Steel.**
McInnes Steel Co., Corry, Pa.
- Disc Grinders.**
Armstrong Bros. Tool Co., Chicago.
- Draft Gears and Draft Rigging.**
Farlow Draft Gear Co., Baltimore, Md.
Gould Coupler Co., New York.
McCord & Co., Chicago.
- Draftsmen's and Engineers' Supplies.**
Kolesch & Co., New York.
- Draftsmen's Tools.**
Starrett Co., L. S., Athol, Mass.
- Draughting Room Supplies.**
Kolesch & Co., New York.
- Draw Bar Attachments.**
Farlow Draft Gear Co., Baltimore, Md.
- Draw Bridge Machinery.**
Nichols, Geo. B. & Bro., Chicago.
- Drill Chucks.**
Standard Tool Co., Cleveland, O.
- Drill Holders.**
Armstrong Bros. Tool Co., Chicago.
- Drill Presses.**
Foote-Burt Co., Cleveland, O.
Garvin Machine Co., New York.
- Drills, Reamers, Etc.**
McInnes Steel Co., Corry, Pa.
Standard Tool Co., Cleveland, O.
- Drill Sockets.**
Standard Tool Co., Cleveland, O.
- Drilling Machines.**
Foote-Burt Co., Cleveland, O.
Sellers & Co., Wm., Philadelphia, Pa.

GENUINE RAILROAD FINISHES

CROCKETT'S RAILWAY VARNISHES

Railway Body.

A varnish, very durable and brilliant, and specially adapted to finishing passenger coaches and trolley cars. It has a good body, works freely and dries dust-free in ten or twelve hours.

Railway Rubbing.

A varnish, made expressly for undercoats on passenger coaches and trolley cars. It works easily, and can be rubbed in forty-eight hours.

Inside Car.

A varnish, drying with a fine and durable lustre in eight hours. It works easily and is more elastic than ordinary inside varnishes.

Open Car.

For one coat use on electric open cars for the entire surface, including seats, dries hard and with durable lustre.

Engine Finishing.

A medium drying, finishing varnish, made from the hardest gums, designed to withstand the rough usage on a locomotive.

Engine Rubbing.

A varnish for undercoats on locomotives and similar purposes. It works easily, dries quickly, and can be rubbed in from twenty-four to thirty-six hours.

Locomotive Black Finish.

A medium drying and durable black finish or enamel, made from the best materials, and designed to withstand the rough usage on a locomotive.

Smoke Stack.

A slow drying black varnish for locomotive iron work and similar purposes, designed to resist the action of heat and exposure.

Coach Japan.

This japan has been a standard article with railroad painters for many years, and has an unrivaled reputation. It is a very powerful dryer, absolutely reliable and uniform.

Brown Japan.

For freight paints.

Floor Finish.

Where a varnish is required that can be frequently washed with hot or cold water. Can be rubbed or left with a gloss.

Spar Composition.

Composed of the best materials purchasable, is the most durable, the best known and has the largest sale of any Marine Varnish manufactured. Positively salt and fresh water-proof, is invaluable for Exterior Marine Work of any kind, and as its name indicates particularly adapted for Spars of Steamships, Yachts and Canoes. Also a finish for Decks, Outside Doors, Piazza Floors, Store Fronts, etc. It will not crack, turn white or blister.

Primelac.

After making many experiments we have produced this article, which we consider indispensable. It fills the pores of the wood and kills all resinous matter and prevents sweating. It dries hard in a few hours, with smooth surface, and is a firm foundation for the after coat.

THE DAVID B. CROCKETT COMPANY
BRIDGEPORT, CONN.

BUYERS' GUIDE—Continued.

Drilling Machines, Portable.
Coates Clipper Mfg. Co., Worcester, Mass.

Driver Brake Shoes.
Railway Materials Co., Chicago.

Simpson, W. M., Chicago.

Drop Hammers.
Chambersburg Engineering Co., Chambersburg, Pa.

Drop Test Machines.
Whiting Foundry Equipment Co., Harvey, Ill.

Dump Cars.
Ralston Steel Car Co., Columbus, O.

Duplex Drill Lathes.
Garvin Machine Co., New York.

Dust Guards.
Franklin Mfg. Co., Franklin, Pa.

Gould Coupler Co., New York.

Eccentric Rolls.
Ajax Mfg. Co., Cleveland, O.

Electric Cranes.
Case Manufacturing Co., Columbus, O.

Whiting Foundry Equipment Co., Harvey, Ill.

Electric Drills and Grinders.
Macleod & Co., Walter, Cincinnati, O.

Electric Lamp Brackets.
Wells Light Mfg. Co., New York.

Electric Storage Batteries.
Gould Storage Battery Co., New York.

Emery Cloth and Paper.
Baeder, Adamson & Co., Philadelphia, Pa.

Emery Steel.

Pittsburg Crushed Steel Co., Pittsburg, Pa.

Emery Wheel Dressers.
Diamond Saw & Stamping Wks., Buffalo, N. Y.

Engineer's Instruments and Supplies.
Kolesch & Co., New York.

Engineers' Supplies.
Kolesch & Co., New York.

Expanded Metal.
Merritt & Co., Philadelphia.

Expanders, Tube.
Henderer's Sons, A. L., Wilmington, Del.

Files and Rasps.
Nicholson File Co., Providence, R. I.

Fillers.
Lucas, John & Co., Philadelphia, Pa.

Heath & Milligan Mfg. Co., Chicago.

St. Louis Surfacers & Paint Co., St. Louis, Mo.

Fireproof Building Materials.
Franklin Mfg. Co., Franklin, Pa.

Fireproof Paints.
Detroit Graphite Mfg. Co., Detroit, Mich.

Flanges, Pipe.
Jefferson Union Co., Lexington, Mass.

Flanging Machines, Hydraulic.
Chambersburg Engineering Co., Chambersburg, Pa.

Flexible Shafting.
Coates Clipper Mfg. Co., Worcester, Mass.

Flue Cleaners.
Western Tool & Mfg. Co., Springfield, O.

Flue Expanders.
Faessler, J. Mfg. Co., Moberly, Mo.

Flue Welding Machines and Furnaces.
Macleod & Co., Walter, Cincinnati, O.

Flue Rollers.
Faessler, J. Mfg. Co., Moberly, Mo.

Flue Sheet Drills.
Foote-Burt Co., Cleveland, O.

Forging Hammers.
Chambersburg Engineering Co., Chambersburg, Pa.

Forging Machines.
Acme Machinery Co., Cleveland, O.

Ajax Mfg. Co., Cleveland, O.

National Machinery Co., Tiffin, O.

Sellers & Co., Wm., Philadelphia, Pa.

Forgings.
Cleveland City Forge & Iron Co., Cleveland, O.

McInnes Steel Co., Corry, Pa.

Monarch Tool Works, St. Louis, Mo.

Forming Machines.
Ajax Mfg. Co., Cleveland, O.

Garvin Machine Co., New York.

Foundry Equipment and Supplies.
Ph. Bonvillian & E. Ronceray, Paris, France.

Whiting Foundry Equipment Co., Harvey, Ill.

Smith, J. D., Foundry Supply Co., Cleveland, O.

Four-Way Valves.
Homestead Valve Mfg. Co., Pittsburg, Pa.

Freight Car Pains—See Paints.

Friction Buffers.
Gould Coupler Co., New York.

A Rare Opportunity

24-inch B. G. Crank Shaper

Powerful—Accurate

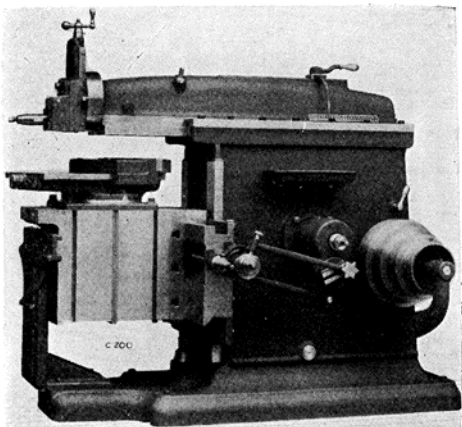

Rigid—Convenient

WE will place a B. G. Crank Shaper in your shop, without order from Pur. Agent, freight prepaid, as a test machine. If not as represented, return at our expense. If the best of its type, pass a requisition for it. **¶** We know our shaper is best adapted to R. R. Shop requirements. We want to prove it to you.

Queen City Machine Tool Co.
Cincinnati, Ohio

A PIPE CUTTING EQUIPMENT

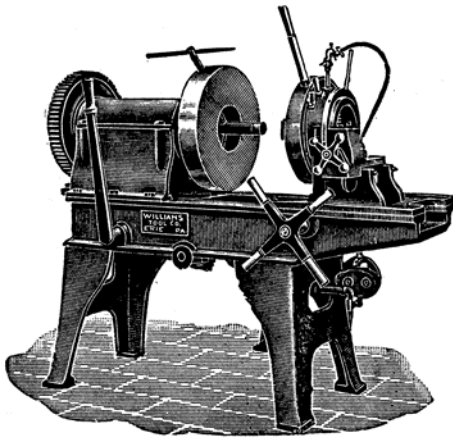

of Williams Machines will meet all requirements of modern work

COMPLETE LINE OF PIPE CUTTING MACHINES
For Up-to-Date Shops

Newly designed, strong construction, rigid and convenient in operation. Quick opening and adjustable dies. Six speed changes without shifting a gear.

7 sizes, capacities 1-4 in. to 12 in.

WILLIAMS TOOL CO.
ERIE, PA.

Best Paint

PARROTT

Manufacturers

and



Varnish Remover

PARROTTS VARNISHES

of the

On the Market

Under License by
Chadelvid Chemical Co.

Established 1846.

THE PARROTT VARNISH CO.

Bridgeport, Conn.

Highest Grade

Car and Locomotive Varnishes

FERGUSON OIL FURNACES

Chicago The Railway Materials Company New York

Nicholson Files

THE CHOICE OF ALL
CRITICAL MECHANICS



Unequaled in
CUTTING POWER — DURABILITY — UNIFORMITY

NICHOLSON FILE CO.

PROVIDENCE, R. I., U. S. A.

WOLFE BRUSH COMPANY

Successors to WOLFE, WALKER & CO., Ltd.

General Offices and Factory:
South 15th and Bingham Sts.
Retail Store, 505 Liberty St.
PITTSBURG, PA.



Manufacturers of Superior

Brushes

Especially Designed for
Rail Roads

THE "GLOBE" VENTILATOR

For ventilating cars and railroad buildings of every
character

The "Globe" Ventilator is absolutely storm and
cinder proof

The "Globe" Ventilator is manufactured by

The Globe Ventilator Company

TROY, N. Y.

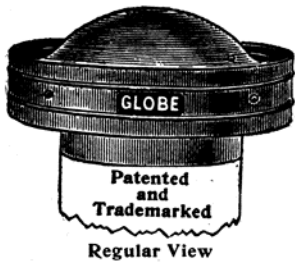

Regular View

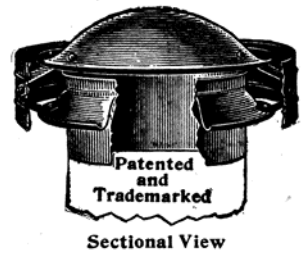

Sectional View

Write for
Sample Card

FERRICO PAINT

Buy
It

Paste, Semi-Paste and Liquid

For Cars, Bridges, Train-sheds, Structural Work and other Wooden and Metallic Surfaces

In preparing Ferrico Paint the most careful attention has been given to the requirements of the surfaces upon which it is to be applied, also to the character of each pigment used.

In grinding, the drying properties of the pigments used in the various colors have been carefully studied and a vehicle used which exactly meets the requirements of each pigment, so that in making reductions the same quality and quantity of thinners can be used in all shades.

MADE IN ELEVEN SHADES AND ELASTIC RED LEAD

Heath & Milligan Mfg Co

Use
It

PAINT AND
COLOR MAKERS



CHICAGO
U · S · A

You'll
Like It

Railway Master Mechanic

(\$1.00 per Year)

Is the leading mechanical journal of railroading, because it is read by more motive power and car shop officials than any other paper. It also carries more advertising in these departments than any other paper. Just as a bank's growth is the measure of confidence in it by its patrons so is a newspaper's growth. The Railway Master Mechanic has shown a greater growth in the past two years (400 per cent.) than any railway journal. It brings many times one dollar's worth of news to its subscribers, and therefore results to its advertisers.

Crandall Publishing Co.

Security Building 130 Nassau St.
CHICAGO NEW YORK

BUYERS' GUIDE—Continued.

Friction Draft Gear.
Gould Coupler Co., New York.
Frogs and Crossings.
Indianapolis Frog & Switch Co.,
Springfield, O.
Front End Paint.
Lucas & Co., John, Philadelphia.
Fuel Oil Equipment for Shops.
Best American Calorific Co., W. N.,
New York.
Rockwell Engineering Co., New York.
Furnaces, Annealing, Melting, Etc.
Best American Calorific Co., W. N.,
New York.
Railway Materials Co., Chicago.
Rockwell Engineering Co., New York.
Simpson, W. M., Chicago.
Furnaces, Tire Heating.
Railway Materials Co., Chicago.
Simpson, W. M., Chicago.
Wells Light Mfg. Co., Chicago.
Furnaces, Foundry.
Railway Materials Co., Chicago.
Simpson, W. M., Chicago.
Furnaces, Natural Gas.
Railway Materials Co., Chicago.
Simpson, W. M., Chicago.
Furnaces, Oil.
Best American Calorific Co., W. N.,
New York.
Railway Materials Co., Chicago.
Rockwell Engineering Co., New York.
Simpson, W. M., Chicago.
Furnaces, Rivet Heating.
Best American Calorific Co., W. N.,
New York.
Railway Materials Co., Chicago.
Rockwell Engineering Co., New York.
Simpson, W. M., Chicago.
Gang Drills.
Foote-Burt Co., Cleveland, O.
Gang Planer Tools.
Armstrong Bros. Tool Co., Chicago.
Gang Tools.
Armstrong Bros. Tool Co., Chicago.
Gantry Cranes.
Whiting Foundry Equipment Co., Har-
vey, Ill.
Gas Furnaces.
Railway Materials Co., Chicago.
Simpson, W. M., Chicago.
Gaskets.
McCord & Co., Chicago.
Gauges, Measuring, All Kinds.
Starrett Co., L. S., Athol, Mass.
Gauges, Surface.
Starrett Co., L. S., Athol, Mass.
Gear Cutters.
Becker-Brainerd Milling Machine Co.,
Hyde Park, Mass.
Standard Tool Co., Cleveland, O.
Graphite.
Detroit Graphite Mfg. Co., Detroit.
Smith, J. D., Foundry Supply Co.,
Cleveland, O.
Graphite Paints.
Detroit Graphite Mfg. Co., Detroit,
Mich.
Heath & Milligan Mfg. Co., Chicago.
Lucas & Co., John, Philadelphia, Pa.
St. Louis Surface & Paint Co., St. Louis,
Mo.
Graphite Pipe Joint Compound.
Detroit Graphite Mfg. Co., Detroit,
Mich.
Granite Roofing.
Stowell Mfg. Co., Jersey City, N. J.
Grinding Holders.
Armstrong Bros. Tool Co., Chicago.
Grinding Machines.
American Wood Working Machinery
Co., New York.
Becker-Brainerd Milling Machine Co.,
Hyde Park, Mass.
Bentel & Margedant Co., Hamilton, O.
Coates Clipper Mfg. Co., Worcester,
Mass.
Landis Tool Co., Waynesboro, Pa.
Sellers & Co., Wm., Philadelphia, Pa.
Smith, H. B. Mach. Co., Smithville, N. J.
Grinding Machine Attachments.
Landis Tool Co., Waynesboro, Pa.
Grinding Materials and Machinery.
Pittsburg Crushed Steel Co., Pittsburg,
Pa.
Springfield Mfg. Co., Bridgeport, Conn.
Grip Sockets.
Standard Tool Co., Cleveland, O.
Hack Saw Blades.
Diamond Saw & Stamping Works, Buf-
falo, N. Y.
Starrett, L. S. Co., Athol, Mass.
Hack Saws.
Diamond Saw & Stamping Works, Buf-
falo, N. Y.
Hack Saw Machines, Power.
Diamond Saw & Stamping Works, Buf-
falo, N. Y.
Hair Felt for Insulation.
Baeder, Adamson & Co., Philadelphia,
Pa.
Hammers, Steam.
Chambersburg Engineering Co., Cham-
bersburg, Pa.

The Only White
That Remains White
In the Vicinity of a Railroad

IS

Oxide of Zinc

Paints based on Oxide of Zinc will not discolor in the presence of sulphur gases.

Such paints are the only ones that will give satisfactory service on station buildings, shops, etc.

The New Jersey Zinc Co.

71 Broadway, New York

FREE, OUR PRACTICAL PAMPHLETS :

The Paint Question
Paints in Architecture
Specifications for Architects
French Government Decrees

BARRETT and DUFF CAR JACKS

are THE acknowledged lifting jacks of the world

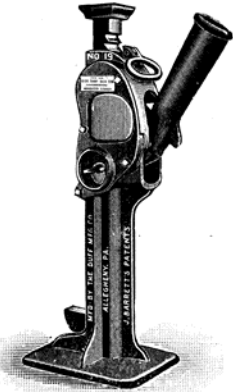

No. 19.

The No. 19 Barrett Jack

is especially designed for car repairing. Easily carried and easily operated. Designed also to grapple low set loads. Lifts and lowers on down stroke of lever only. Capacity, 15 tons.

No. 130 Barrett Geared Ratchet Lever Jack

has a capacity of 35 tons and is particularly designed for the rapid handling of loaded freight cars and heavy loads in general. Single acting, raising the load on the downward movement of the lever only. This Jack permits of great ease of operation and is quick acting.

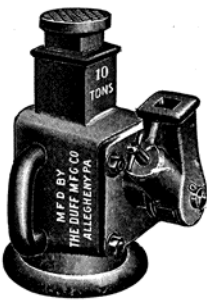

No. 58.

No. 58 Cone Bearing Journal Jack

weighs 39 pounds and has a raise of 5 inches. One man can easily replace the brasses in a truck with one of these jacks.

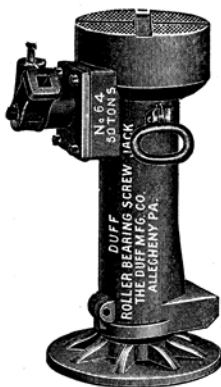

Ball-Bearing Jack.

The Duff Ball-Bearing Screw Jacks

are made to interchange with Duff Roller Bearing Screw Jacks, so that any shop having our jacks equipped with roller bearing can easily change them to ball-bearing jacks if desired. We shall be pleased to send full information regarding our complete line of Jacks, which are made in capacities of from 1 to 75 tons.

The Duff Manufacturing Company

PITTSBURG, PA.

Works, Allegheny, Pa.

New York Office, 26 Cortlandt St.

BUYERS' GUIDE—Continued.

Hand Lathes.
Garvin Machine Co., New York.
Hand Pipe Cutters.
Armstrong Mfg. Co., Bridgeport, Conn.
Hand Power Saws.
Marston Co., J. M., Boston, Mass.
Headlights, Acetylene.
MacLeod & Co., Walter, Cincinnati, O.
Heating Furnaces, Gas.
Railway Materials Co., Chicago.
Simpson, W. M., Chicago.
Heat Proof Enamel.
Lucas & Co., John, Philadelphia, Pa.
High Pressure Valves.
Homestead Valve Mfg. Co., Pittsburg, Pa.
High Speed Steel.
Baldwin Steel Co., New York.
McInnes Steel Co., Corry, Pa.
High Speed Cutting Tools.
Armstrong Bros. Tool Co., Chicago.
High Speed Tire Steel.
McInnes Steel Co., Corry, Pa.
Hoisting Machinery.
Case Mfg. Co., Columbus, O.
Hoists, Electric, Hand Power, Etc.
Case Mfg. Co., Columbus, O.
Sellers & Co., Wm., Philadelphia, Pa.
Smith, J. D., Foundry Supply Co., Cleveland, O.
Whiting Foundry Equipment Co., Harvey, Ill.
Hollow Chisel Mortisers.
American Wood Working Machinery Co., New York.
Bentel & Margendant Co., Hamilton, O.
Greenlee Bros. & Co., Chicago.
Hot Pressed Nut Machines.
Ajax Mfg. Co., Cleveland, O.
Hydraulic Jacks.
Henderer's, A. L. Sons, Wilmington, Del.
Watson-Stillman Co., New York.
Hydraulic Machinery and Tools.
Henderer's Sons, A. L., Wilmington, Del.
Watson-Stillman Co., New York.
Chambersburg Engineering Co., Chambersburg, Pa.
Hydraulic Punches.
Slocumb & Co., F. F., Wilmington, Del.
Watson-Stillman Co., New York.
Index Center.
National Machinery Co., Tiffin, O.
Stockbridge Machine Co., Worcester, Mass.
India Oil Stones.
Baeder, Adamson & Co., Philadelphia, Pa.
Injectors.
Nathan Mfg. Co., New York City.
Instruments, Engineering and Surveying.
Hanna Mfg. Co., Troy, N. Y.
Kolesch & Co., New York.
Insulating Felt.
Baeder, Adamson & Co., Philadelphia, Pa.
Iron Fillers and Paints.
St. Louis Surfacer & Paint Co., St. Louis, Mo.
Iron for Staybolts.
Cleveland City Forge & Iron Co., Cleveland, O.
Jacks.
Duff Mfg. Co., Allegheny, Pa.
Henderer's, A. L. Sons, Wilming., Del.
Watson-Stillman Co., New York.
Jacks, Hydraulic.
Henderer's, A. L. Sons, Wilmin., Del.
Watson-Stillman Co., New York.
Japan Oil.
Lucas & Co., John, Philadelphia, Pa.
Jib Cranes.
Whiting Foundry Equipment Co., Harvey, Ill.
Journal Boxes.
Gould Coupler Co., New York.
McCord & Co., Chicago.
Journal Box Packing.
Franklin Mfg. Co., Franklin, Pa.
Journal Packing.
Franklin Mfg. Co., Franklin, Pa.
Knife Grinding Machinery.
American Wood Working Machinery Co., New York.
Bentel & Margendant Co., Hamilton, O.
Lagging, Asbestos.
Franklin Mfg. Co., Franklin, Pa.
Lamp Brackets, Electric.
Wells Light Mfg. Co., New York.
Lamp Jacks.
Globe Ventilator Co., Troy, N. Y.
Lamps, Electric.
Cooper-Hewitt Electric Co., New York.
Lamps, Mercury Vapor.
Cooper-Hewitt Electric Co., New York.
Lathe Dogs.
Armstrong Bros. Tool Co., Chicago.